

OPERATING INSTRUCTIONS MANUAL

(Please retain for future reference)

For FRHR-100N/P/PQD RADIANT CONSTRUCTION HEATERS INDOOR USE ONLY



**CERTIFIED FOR USE IN CANADA AND U.S.A.
As per Standard ANSI Z83.7 2000/
CSA 2.14 2000 Gas Fired Construction Heaters Unvented /Unattended Type.**



**FLAGRO INDUSTRIES LIMITED
ST. CATHARINES, ONTARIO
CANADA**

GENERAL HAZARD WARNING:

FAILURE TO COMPLY WITH THE PRECAUTIONS AND INSTRUCTIONS PROVIDED WITH THIS HEATER, CAN RESULT IN DEATH, SERIOUS BODILY INJURY AND PROPERTY LOSS OR DAMAGE FROM HAZARDS OF FIRE, EXPLOSION, BURN, ASPHYXIATION, CARBON MONOXIDE POISONING, AND/OR ELECTRICAL SHOCK.

ONLY PERSONS WHO CAN UNDERSTAND AND FOLLOW THE INSTRUCTIONS SHOULD USE OR SERVICE THIS HEATER.

IF YOU NEED ASSISTANCE OR HEATER INFORMATION SUCH AS AN INSTRUCTIONS MANUAL, LABELS, ETC. CONTACT THE MANUFACTURER.

WARNING:

FIRE, BURN, INHALATION, AND EXPLOSION HAZARD. KEEP SOLID COMBUSTIBLES, SUCH AS BUILDING MATERIALS, PAPER OR CARDBOARD, A SAFE DISTANCE AWAY FROM THE HEATER AS RECOMMENDED BY THE INSTRUCTIONS. NEVER USE THE HEATER IN SPACES WHICH DO OR MAY CONTAIN VOLATILE OR AIRBORNE COMBUSTIBLES, OR PRODUCTS SUCH AS GASOLINE, SOLVENTS, PAINT THINNER, DUST PARTICLES OR UNKNOWN CHEMICALS.

WARNING:

NOT FOR HOME OR RECREATIONAL VEHICLE USE.

This heater is designed and approved for use as a construction heater under ANSI Z83.7 2000 and CSA 2.14 2000 Gas Fired Construction Heaters for indoor use Only.

We cannot anticipate every use which may be made of our heaters. CHECK WITH YOU LOCAL FIRE SAFETY AUTHORITY IF YOU HAVE QUESTIONS ABOUT APPLICATIONS.

Other standards govern the use of fuel gases and heat producing products in specific applications. Your local authority can advise you about these.

WARNING:

INTENDED USE IS PRIMARILY THE TEMPORARY HEATING OF BUILDINGS UNDER CONSTRUCTION, ALTERATION, REPAIR OR EMERGENCIES ONLY.

ALWAYS PROVIDE ADEQUATE VENTILATION. 1 SQ. IN. OF FRESH AIR MUST BE SUPPLIED FOR EVERY 1000 BTUH OF HEAT.

THIS HEATER SHALL BE INSTALLED SUCH THAT IT IS NOT DIRECTLY EXPOSED TO WATER SPRAY, RAIN AND/OR DRIPPING WATER.

MINIMUM CLEARANCE TO COMBUSTIBLES

TOP: 48 inches
SIDES: 30 inches
BOTTOM: 0 inches

INLET PRESSURES

FRHR-100N	Natural gas	MINIMUM Supply Pressure	7" W.C.
		MAXIMUM Supply Pressure	14" W.C.
FRHR-100P/PQD	Propane	MINIMUM Supply Pressure	11" W.C.
		MAXIMUM Supply Pressure	14" W.C.

MAINTENANCE

1. This construction heater should be inspected before each use. All burner ports should remain clear and the valve should be inspected for any possible damage. The heater should be test fired before each use. High pressure air may be used to blow out the inside of the burner.
2. The heater should be inspected annually by a qualified service person.
3. The heater must be kept clear and free from combustible materials, gasoline and other flammable vapors and liquids.
4. The hose assembly shall be visually inspected prior to each use of the heater. If it is evident there is excessive abrasion or wear, or the hose is cut, it must be replaced prior to the heater being put into operation. The replacement hose assembly shall be supplied by Flagro Industries Limited. Please see Parts List.

INSTALLATION

All natural gas heaters must be installed by a qualified gas fitter and must conform to local installation codes or, in the absence of local codes, with the National Fuel Gas Code ANSI Z223.1/NFPA 54 and the Natural Gas and Propane Installation Code, CSA B149.1. The natural gas heater is provided with a ½" male quick disconnect fitting. The hose assembly used to install this heater must be a Type 1 CGA/AGA approved hose assembly equipped with a ½" female quick disconnect socket to mate with the inlet fitting. Before lighting the heater, all connections must be leak checked using a soap and water solution. The heater must be installed on a level surface.

FOR A HEATER CONNECTION TO AN LP-GAS SUPPLY CYLINDER

1. The installation must conform with local codes or, in the absence of local codes, to the Standard for the Storage and Handling of Liquefied Petroleum Gases, ANSI/NFPA 58 and the Natural Gas and Propane Installation Code, CSA B149.1.
2. The hose assembly used to install this heater must be a Type 1 CGA/AGA approved hose assembly. The heater must be located at least 20-ft (6.10m) from any LP-gas cylinder.
3. The heater should be installed using a LP-gas cylinder with a minimum capacity of 100-lbs.
4. The cylinders used to supply this heater must provide for vapor withdrawal **only**.
5. The heater must be connected with a "low pressure" regulator and POL inlet fitting. The POL fitting is connected to the LP-gas cylinder by turning the POL nut counter clockwise and tightened using a wrench. All connections must be checked for leaks using a soap and water solution or approved leak detector solution. Use a wrench and turn the POL nut clockwise to disconnect the heater from the cylinder.
6. The cylinder must be disconnected from the heater when not in use.
7. The heater is to be stored indoors, the connection between the LP-gas supply cylinder(s) and the heater must be disconnected and the cylinder(s) removed from the heater and stored in accordance with Chapter 5 of the Standard for the Storage and Handling of Liquefied Petroleum Gases, ANSI/NFPA 58 and CSA B149.1, Natural Gas and Propane Installation Code.

LIGHTING INSTRUCTIONS

1. Ensure the heater is connected to the proper source of gas and proper inlet pressures are supplied. The heater must be installed by a qualified installer.



2. Set thermostat knob (green button) to high position. Rotate the control knob (black) counter clockwise to **'PILOT'** position. Depress and hold control knob.

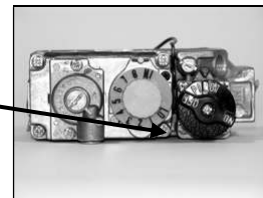

3. Light the pilot burner using ignitor button
Release the knob after 60 seconds. Pilot will remain lit. Main burner will remain off.



4. Turn control knob counterclockwise to **'ON'** position. Main burner will light.

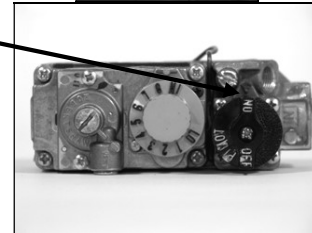

5. If the main burner fails to light, turn the control knob clockwise to the **'OFF'** position, wait 5 minutes and repeat step 3.

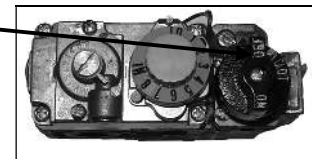

6. The green knob controls the thermostat option. This will light and extinguish the main burner as the temperature fluctuates.

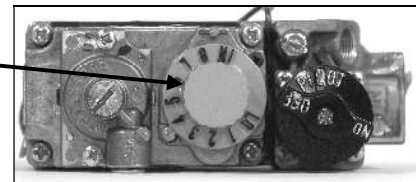

SHUT OFF INSTRUCTIONS

1. Turn the control knob clockwise to the **'OFF'** position. Both main burner and pilot burners will extinguish.
2. Turn off source of fuel.



IMPORTANT NOTES FOR SUCCESSFUL LIGHTING AND OPERATIONAL SAFETY

1. For safety purposes, this heater model is equipped with a “tip over switch” which will prevent the heater from operating or being lit if it is bumped, jarred, knocked over or positioned on an angle. In order to light and operate properly, this heater **MUST** be placed on a flat horizontal surface in an upright position.



CORRECT POSITION



INCORRECT POSITION

2. The tip over switch is interlocked with the thermocouple. The connections on the thermocouple switch must be kept clean and tight at all times to ensure proper operation of these components.

Thermocouple block

Tip over switch

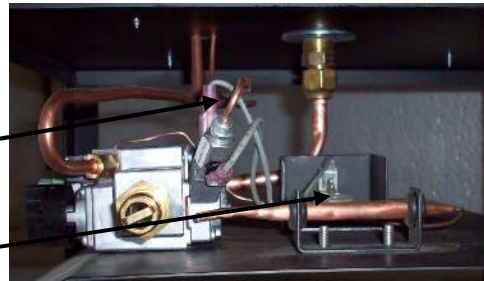

3. While the heater unit does not require a filter, the unit must be kept clean and the burner and pilot assembly must be kept free of dust and dirt to ensure optimal and safe operation at all times

Store the unit in a clean environment and make sure that the unit is leak checked and cleaned before every use. Do not clean the unit with volatile substances. (see maintenance on Page 3)



PARTS DIAGRAM FRHR-100P/N

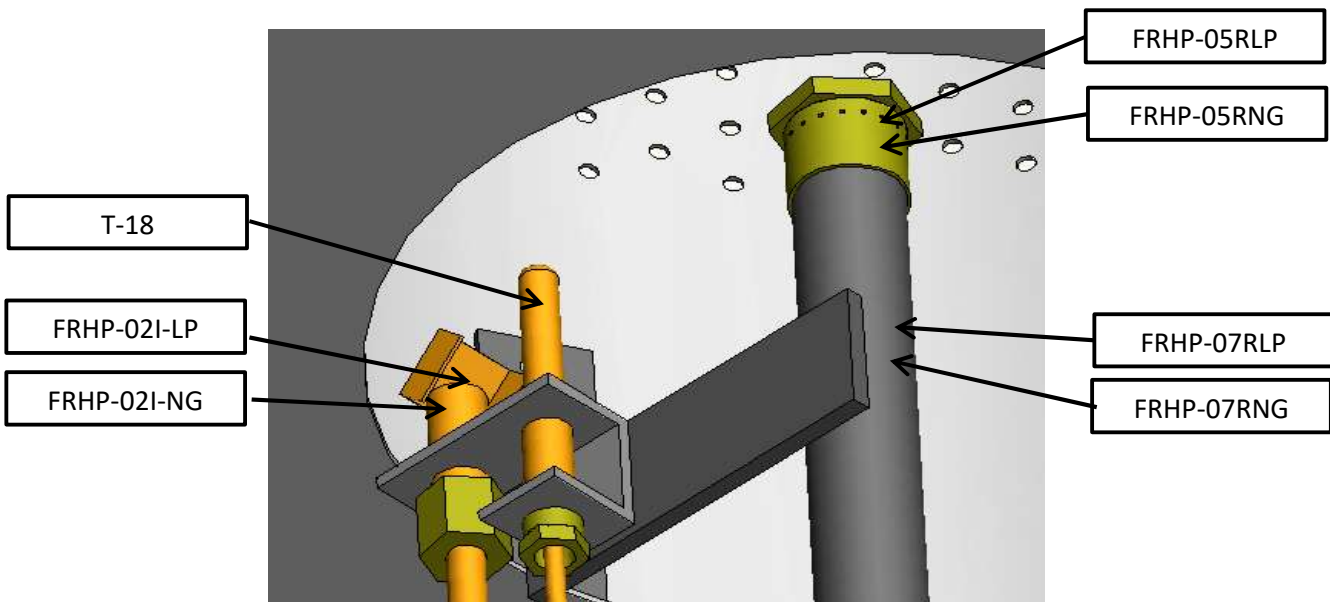
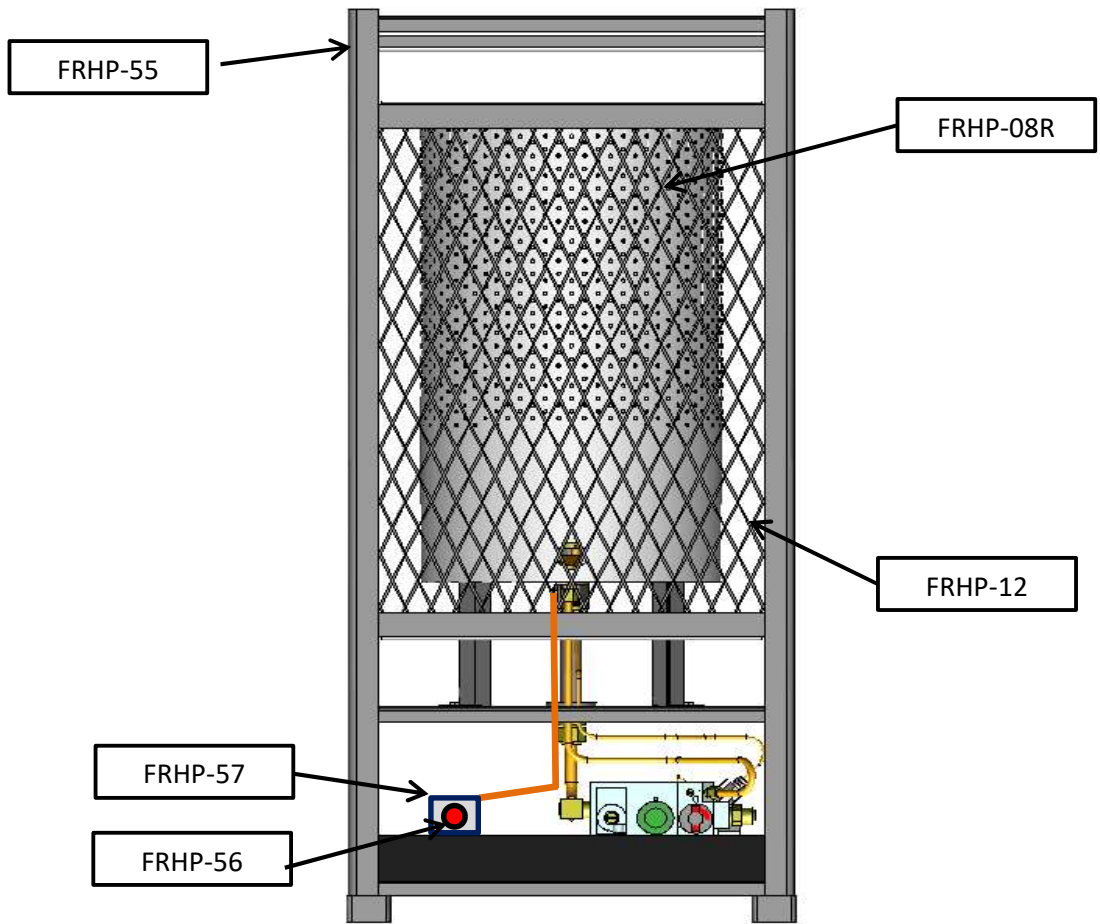

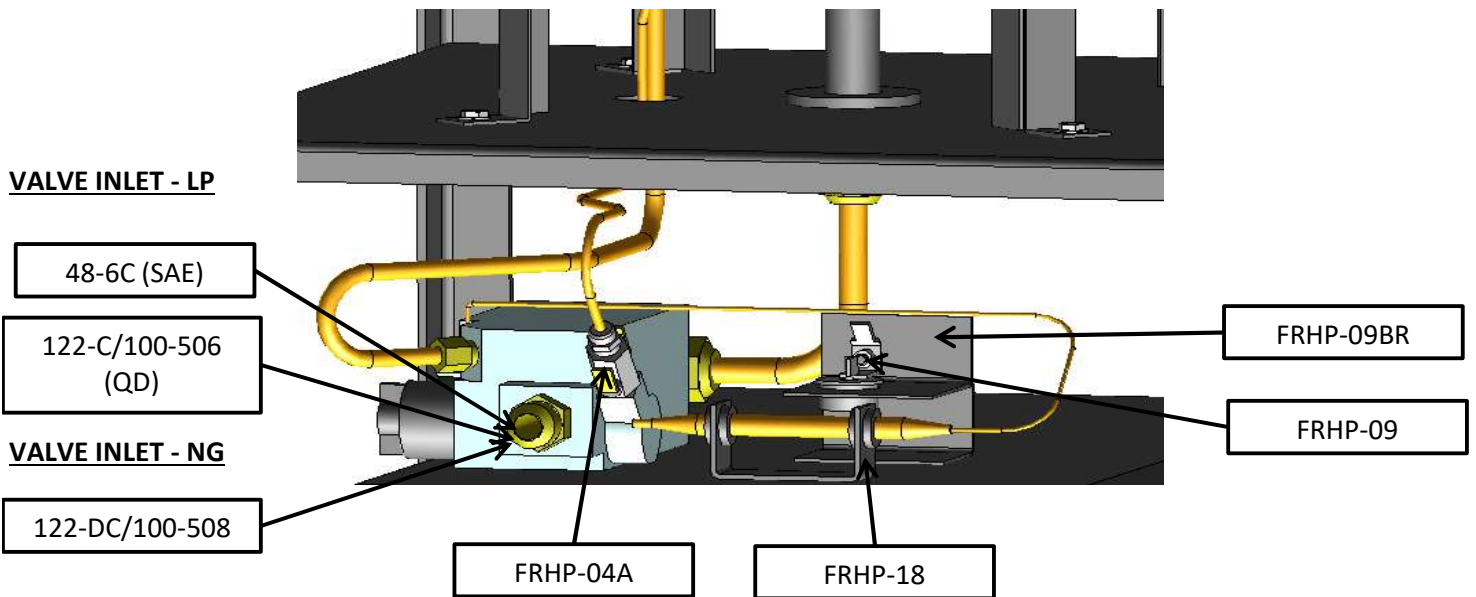
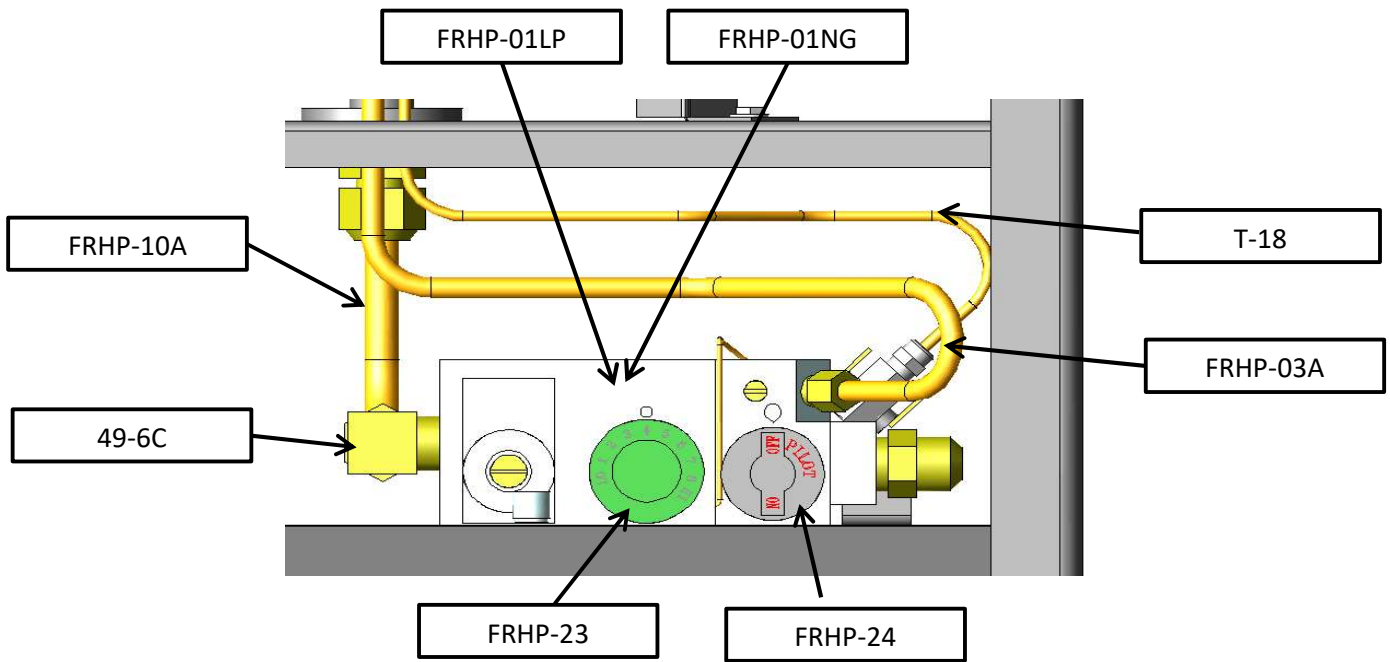

PARTS LIST FOR FRHR-100N/P/PQD

Part Number	Part Description
FRHP-01NG	GAS CONTROL VALVE C/W THERMOSTAT - NG
FRHP-01LP	GAS CONTROL VALVE C/W THERMOSTAT - LP
FRHP-02I-NG	PILOT ASSEMBLY C/W IGNITOR WIRE - NG
FRHP-02I-LP	PILOT ASSEMBLY C/W IGNITOR WIRE - LP
FRHP-56	PIEZO IGNITOR
FRHP-03A	PILOT LINE (CURRENT)
FRHP-04A	CUT-OFF SWITCH
T-18	18" THERMOCOUPLE
FRHP-05RLP	BURNER ORIFICE LP (CURRENT)
FRHP-05NG	BURNER ORIFICE NG (CURRENT)
FRHP-07RLP	BURNER ASSEMBLY- LP (CURRENT)
FRHP-07RNG	BURNER ASSEMBLY - NG (CURRENT)
FRHP-08R	STAINLESS EMITTER GRID (CURRENT)
FRHP-09	TIP-OVER SWITCH C/W WIRE
FRHP-09BR	TIP-OVER SWITCH BRACKET
FRHP-10A	3/8" LOW PRESSURE FIRE LINE C/W FLARE NUTS
FRHP-11	REDUCING NIPPLE 1/2" X 3/8"
FRHP-12	SAFETY SCREEN ASSEMBLY (TWO REQUIRED)
FRHP-13A	TWO STAGE REGULATRO - LP
FRHP-16	3/8" X 5" NIPPLE (USE FOR WR CONTROL)
FRHP-17	1/2" NG REGULATOR (5PSI MAX)
FRHP-18	THERMO BULB BRACKET C/W GROMMETS
FRHP-19	BLACK CONTROL KNOB (FOR WR CONTROL)
FRHP-21	1/4" COMPRESSION NUT & SLEEVE FOR PILOT LINE
FRHP-22	1/4" EXTENDED BREAKAWAY FOR PILOT LINE
FRHP-23	GREEN KNOB - MAIN
FRHP-24	BLACK KNOB - PILOT
FRHP-50	CONVERSION KIT FOR FRHR NG TO LP (CDN)
FRHP-51	CONVERSION KIT FOR FRHR LP TO NG (CDN)
FRHP-52	CONVERSION KIT FOR FRHR LP TO NG (USA)
FRHP-53	CONVERSION KIT FOR FRHR NG TO LP (USA)
FRHP-55	HEATER FRAME - ONLY

2103-E-CGA	3/4" FNPT BALL VALVE
100-006	3/8" QUICK DISCONNECT SOCKET - FEMALE
100-506	3/8" QUICK DISCONNECT PLUG - MALE
100-008	1/2" QUICK DISCONNECT SOCKET - FEMALE
100-508	1/2" QUICK DISCONNECT PLUG - MALE
100-010	3/4" QUICK DISCONNECT SOCKET - FEMALE
100-510	3/4" QUICK DISCONNECT PLUG - MALE

	ACCESSORIES
FRHP-101	NG HOSE ASSEMBLY - C/W 50FT X 3/4" TYPE 1 , 3/4" BALL VALVE, 1/2" FEMALE QD SOCKET & 3/4" MALE QD PLUG
FRHP-101 (75)	NG HOSE ASSEMBLY - C/W 75FT X 3/4" TYPE 1 , 3/4" BALL VALVE, 1/2" FEMALE QD SOCKET & 3/4" MALE QD PLUG
FRHP-101600LP	LP HOSE ASSEMBLY - C/W 50FT 1/2" TYPE 1 HOSE, 1/2" BALL VALVE, 3/8" FEMALE QD SOCKET & FITTED REGULATOR
FRHP-101900LP	LP HOSE ASSEMBLY - C/W 75FT 1/2" TYPE 1 HOSE, 1/2" BALL VALVE, 3/8" FEMALE QD SOCKET & FITTED REGULATOR
MAN-E1	SINGLE MANIFOLD - ENBRIDGE
MAN-E2	DUAL MANIFOLD - EMBRIDGE
MAN-U1R	SINGLE MANIFOLD - UNION GAS
MAN-U2R	DUAL MANIFOLD - UNION GAS